



Wood-burning stoves and storage heating stoves

# Nordic lifestyle in your home



# INDEX

04	Stoves from the North
08	KLIMA PLUS

---

## Cast iron stoves with storage capacity

10	COLONA
14	EDDA
22	GREENA
24	DELTA plus
26	NOVIA plus
28	ANTIGUA H
28	COLONA lite
30	CORNA

---

## Cast iron stoves

38	CORNA PS
40	PEPPA
44	NOVIA
46	VISPA
48	APELLA

Why should I choose KLIMA PLUS?



Which oven is right for me?

## Planning your water technology system

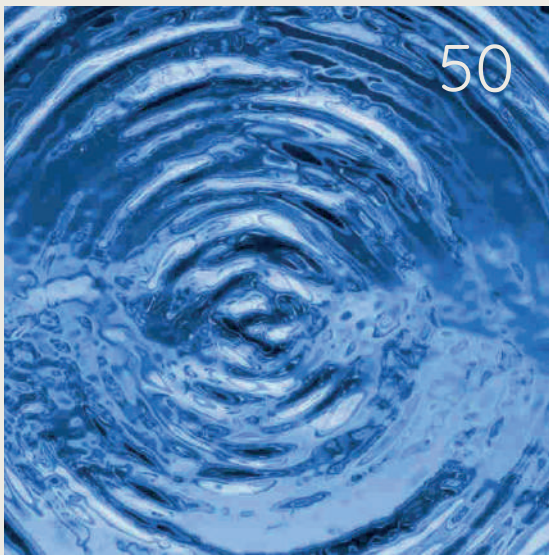

LEDATRONIC and LUC

## Water technology

How does water technology work? 50

GREENA W 52

NOVIA W 54

DELTA W 56

FONDIA 58

## electronics

LEDATRONIC 60

LUC 62

Heating support device 64

Airflow volume regulator 66

Technical specifications 68

Imprint 75



Colours



Models



with storage



KLIMA plus

# Wood-burning Stoves

## Quality that has been impressing since 1873

To meet the highest standards of design, functionality, individuality and sustainability, we have developed an selection of wood-burning stoves for you..

Like no other name in the industry, LEDA stands for tradition, premium quality, durability, comfort and innovation. Since our founding in 1873, quality has been our top priority – and that has not changed to this day.

Our stoves are more than just sources of heat: they are efficient, durable, powerful and individually designed – for a feel-good atmosphere that you can enjoy every day.



cast iron –  
our trademark.

We combine traditional craftsmanship with state-of-the-art technology. Our products are made from the finest materials – above all, high-quality cast iron. This material has always been our trademark, as it offers unrivalled advantages: virtually unlimited service life, excellent heat storage, extreme heat resistance, dimensional stability and the ability to realise even the finest details in the design.

produce any annoying crackling noises during heating or cooling – another reason why cast iron is synonymous with quality for us.

LEDA – Fire, fascinating Frisian!

– Dr Fynn Willem Lohe  
Managing Director

And best of all: with an LEDA fireplace, you can enjoy the peace and quiet you deserve. Unlike other materials, cast iron does not



Quality casting is our promise



Development, production and quality assurance in East Frisia

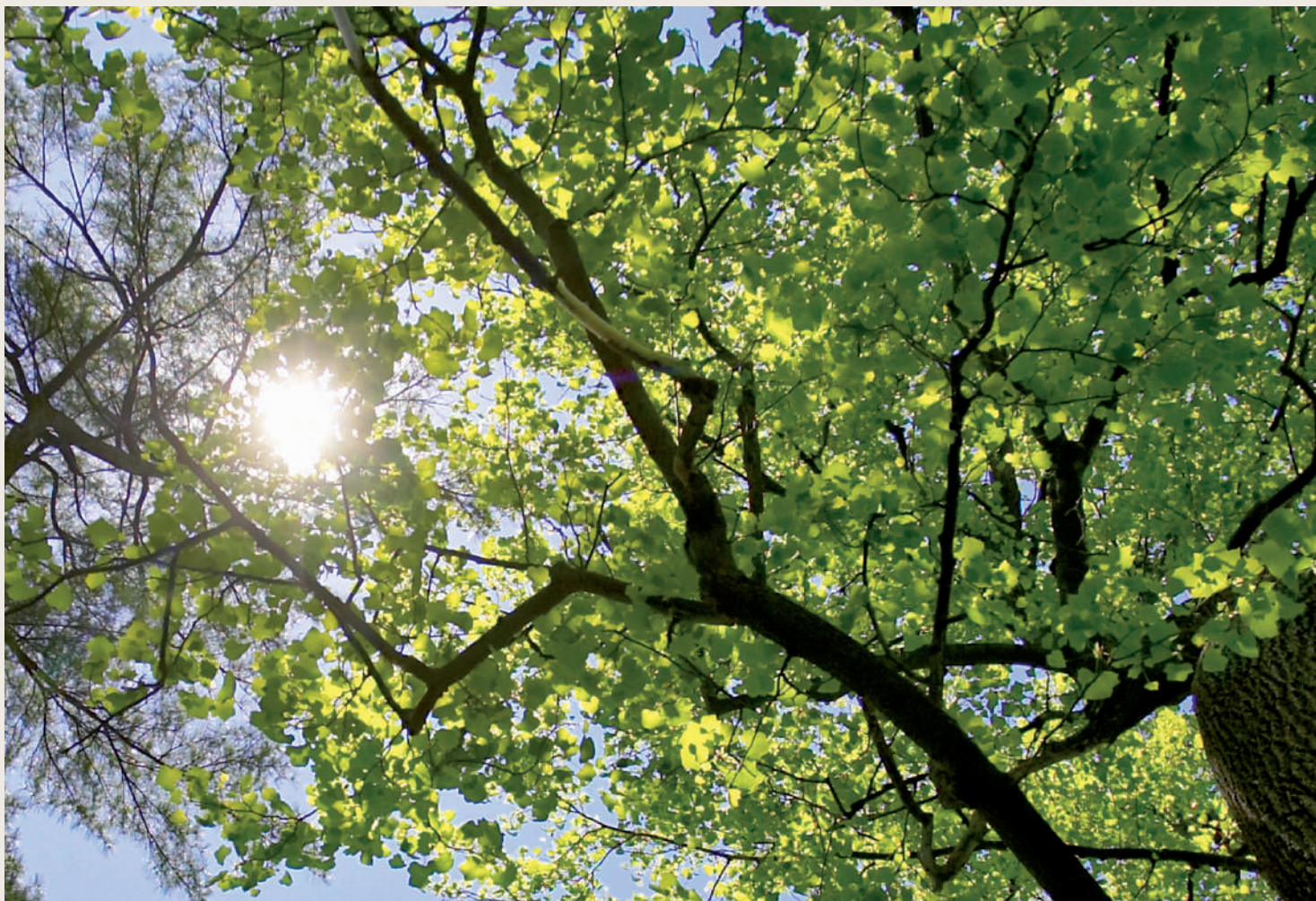

## KLIMA PLUS – the new generation

Experience the best for your home

Are you looking for a heating solution that is efficient and climate-friendly? Then KLIMA PLUS is the answer! With our new generation, we offer products that represent the future of heating.

As a leading manufacturer of high-quality cast products, LEDA is always striving to create sustainable and innovative solutions for the future and to effectively reduce emissions.

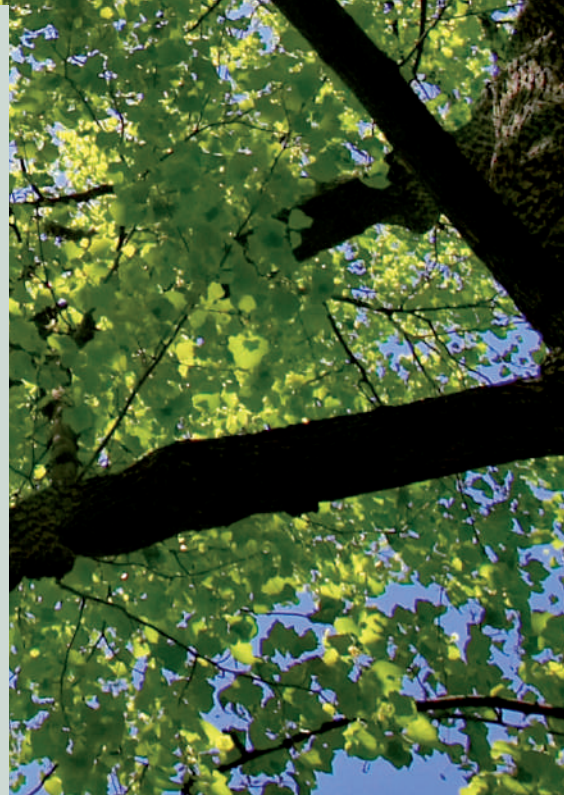



# The future of sustainable heating

## Innovation

KLIMA PLUS stands for products that are not only state-of-the-art in terms of technology, but also take into account factors that significantly influence the heating behaviour of a stove.

LEDA takes into account all components for an efficient and environmentally conscious heating experience: the stove, the controls and the chimney.

## Comfort

Proper operation is a crucial factor in low-emission fireplace operation. That is why we have designed our stoves to be easy to use.

## Quality

LEDA stands for high-quality products that are designed to last. Our stoves are made in Germany from top-quality cast iron and are subject to strict quality controls. This ensures that even the highest standards are always met.



## Why should you choose KLIMA PLUS?



Our appliances bearing the KLIMA PLUS logo offer a wide range of features that ensure effective, low-emission heating and take into account the entire stove situation – the stove itself, its operation and the chimney. KLIMA PLUS provides an answer to the issue of fine dust and other pollutants.



#### 01 | Airflow volume regulator (VFC)

Our holistic stove approach uses an innovative air valve in the combustion chamber floor, which allows for convenient and user-friendly individual adjustment to the chimney. This reduces wood consumption, optimises combustion and uses heat efficiently – better than with conventional throttle valves and secondary air devices.

#### 02 | Recessed fire chamber bottom

This advanced combustion technology features a recessed, rust-free fire chamber bottom where the combustion process takes place. The design ensures more efficient fuel utilization, higher heating performance, and reduced wood consumption. For these reasons, we have replaced the classic grate system with a recessed fire chamber bottom.

#### 03 | Catalyst

The integration of a catalyst, which can also be retrofitted, effectively reduces emissions of pollutants such as carbon monoxide (CO), hydrocarbons (VOC) and carbon (OGC).

#### 04 | Monitoring tool / Combustion air

- a) The heating support device provides process information for optimal operation. If the output is too high or too low, you can adjust your settings.
- b) LEDATRONIC ensures automatically controlled air adjustment in the oven and offers convenience and effectiveness in every operating mode.



COLONA in dark red enamel

# COLONA – a gem of storage tech- nology

**Keeps you warm for hours after the fire has gone out.**

A storage stove that stores the energy from the flames in a large chamotte storage core, thereby releasing heat into the living space for many hours after the fire has long since gone out.



[1.7 KW] 

# COLONA

Wood-burning stove with 480 kg of  
chamotte and cast iron storage mass



Colour variant: petrol  
blue enamelled

COLONA in white enamel



#### COLONA Facts:

- white, dark green, petrol blue or dark red enameled or black lacquered
- Dimensions (H/W/D): approx. 176/49/50 cm
- Accessories: Turning base, LUC, LEDATRONIC

Elegant, slimline wood-burning stove, ideal for low-energy homes. The low, adjusted room heating output of 1.7 kW\* releases heat gradually, preventing the living space from overheating.



\* based on heat dissipation over many hours (= discharge period)



Heating gases directed through chamotte core: efficient long-term heat storage

COLONA in black lacquer

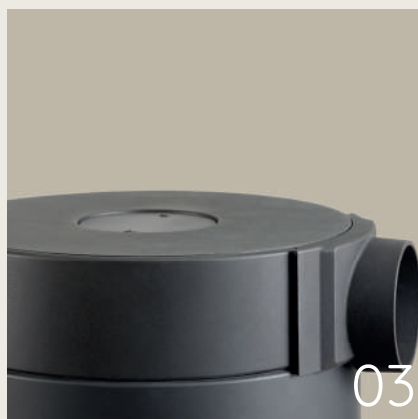

## The special features at a glance

01 | Round door with double glazing

02 | Spiral handle – thanks to its heat-dissipating spiral shape, the handle itself remains pleasantly cool to the touch even at high temperatures.

03 | Flue pipe connection either at the rear or top

04 | Cast iron storage stove with chamotte core: Even a small amount of fuel provides many hours of soothing warmth (1 x 4.2 kg of wood: over 10 hours of heat, tested in accordance with EN 15250). The delayed heat release prevents the living space from overheating.



EDDA tea in dark green enamel

# EDDA – Retro design with advanced technology

**Three models – painted or coloured enamelled, with warming compartment or chamotte storage compartment**

EDDA is available in two practical sizes: the smaller version with a height of 92 cm ("small") and the larger version with a height of 130 cm. Choose between a cast iron warming compartment for more convection heat and high efficiency or an attachment with 50 kg of chamotte bricks that store long-lasting heat and release it evenly. Perfect for your home, depending on your needs and room size.



EDDA small  
[ 6 KW ] 

# EDDA

Retro oven - tradition meets  
innovation for your home!



For more information  
about KLIMA PLUS, sim-  
ply scan the QR code.



EDDA small painted black

EDDa tea/ EDDA plus  
[ 6 KW ] 



#### EDDA Facts:

- painted black, dark green or petrol blue enamelled
- 3 models: EDDA small, EDDA tea with warm-keeping space, EDDA plus with chamotte storage on top
- Dimensions (H/W/D):  
92/54/45 cm – EDDA small  
129/54/45 cm – EDDA tea, EDDA plus
- Made entirely from high-quality LEIDA cast iron with stylish decorative details
- KLIMA PLUS – including airflow volume regulator and recessed fire chamber bottom
- Accessories: Electronic heating support device, catalyst, LUC

The design of the EDDA combines retro-inspired elements with modern charm, giving the stove a unique character.





The EDDA tea in petrol blue enamel

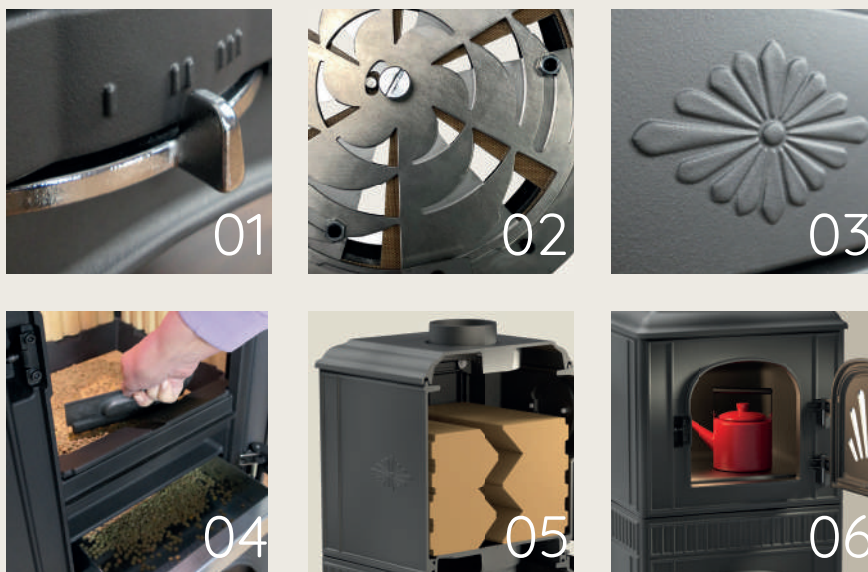

## The special features at a glance

01 | Chrome-plated handles in retro style for precise adjustment and an elegant, classic look

02 | Volume flow regulator included – innovative air valve in the bottom of combustion chamber for adjusting the chimney draught

03 | Lovingly crafted, stylish details that can only be achieved with high-quality cast iron

04 | Easy ash removal thanks to integrated ash slide and ash pan / Recessed fire chamber bottom for high fuel utilisation, better heating performance and lower wood consumption

05 | EDDA plus has a 50 kg chamotte storage unit, which ensures prolonged heat emission of approx. 4.5 hours.

06 | EDDA tea for more convection heat with a warming space for tea or other delicacies

[ 6 KW ] 

# GREENA

Modern wood-burning stove: upgradeable with storage elements, catalyst and electronic combustion air control



For more information about KLIMA PLUS, simply scan the QR code.





#### GREENA Facts:

- painted black
- 2 models: GREENA pure with a smooth surface and GREENA nature with a natural texture
- Dimensions (H/W/D): 134/46/48 cm
- Up to six cast iron storage elements, each weighing 15 kilograms, can be integrated into the upper segment of the stove.
- KLIMA PLUS stove – including airflow volume regulator and recessed fire chamber bottom
- Accessories: Cast iron storage inserts, swivel console, electronic heating support device, catalyst, LEDATRONIC, LUC

GREENA nature – with relief in an elegant tree bark look for a natural living atmosphere.



[ 6 KW ] 

# DELTA PLUS

Wood-burning stove with 45 kg solid cast iron storage elements





#### DELTA plus Facts:

- painted black
- Dimensions (H/W/D): 133/50/49 cm
- Includes 45 kg cast iron storage elements for effective heat utilisation
- Accessories: Electronic heating support device, LEDATRONIC, LUC

The DELTA plus is the ideal wood-burning stove for anyone who values comfort and efficiency. The integrated heat accumulator stores the heat generated and continues to release it for up to three hours after the fire has gone out.



[ 6 KW ] 

# NOVIA PLUS

Wood-burning stove with integrated cast iron heat accumulator



NOVIA plus



#### NOVIA plus Facts:

- painted black
- Dimensions (H/W/D): 130/45/45 cm
- Includes 45 kg cast iron storage elements for effective heat utilisation
- Accessories: Turning base, LUC, electronic heating support device, LEDATRONIC

Cast iron quickly stores heat and releases it as radiant heat over a longer period of time. Thanks to the integrated 45 kg storage insert, the heat is retained for several hours even after the flames have gone out.





The COLONA lite in white enamel

# COLONA lite – Variable in height, colour and storage options

## Store heat on demand

The COLONA lite quickly ensures pleasant temperatures. It is available in various heights and, depending on the model, can be equipped with cast iron storage elements (from 45 to 135 kg) to provide heat even after the fire has gone out.



[ 6 KW ] 

# COLONA LITE

All-round cast iron in a modern design



Colour options: dark red and petrol blue enameled



COLONA lite painted black



#### COLONA lite facts:

- white, dark green, petrol blue or dark red, enamelled or painted black
- 3 sizes (H/W/D):  
 approx. 177/49/49 cm – 6 rings  
 approx. 138/49/49 cm – 3 rings  
 approx. 125/49/49 cm – 2 rings
- Turning base, cast iron storage insert, cast iron cover plate, LUC, LEDATRONIC

The COLONA lite wood-burning stove with a rated heat output of 6 kW quickly ensures cosy temperatures. It is available in different heights and can be optionally equipped with cast iron storage elements.







The CORNA in white enamel

# CORNA – Heating with prescient technologies

## Fire in the square

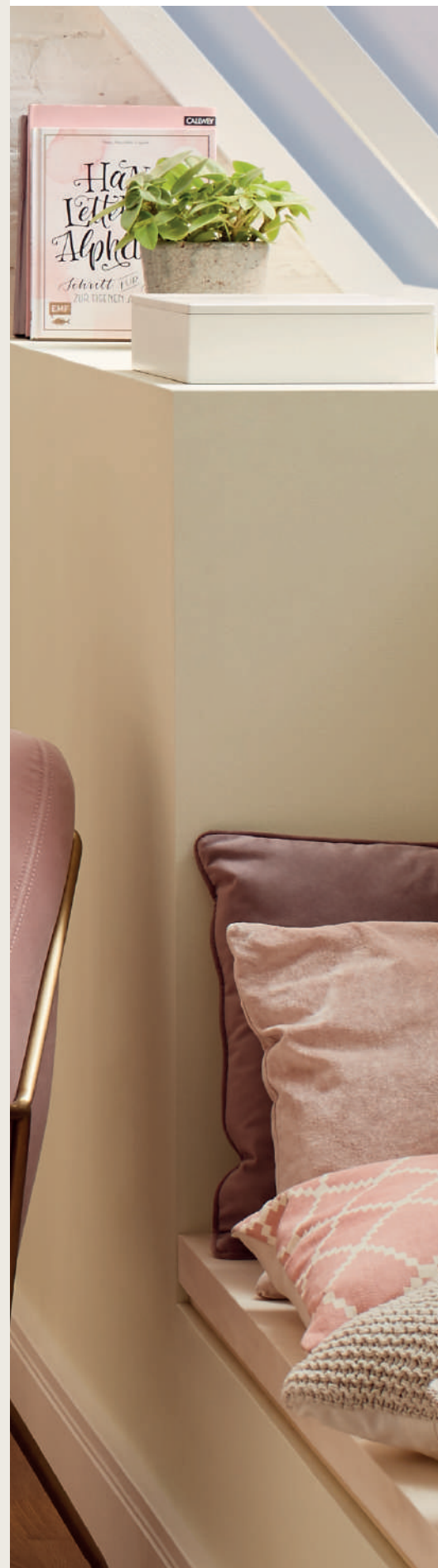
CORNA offers a heat output of 4 to 6 kW and provides pleasant, cosy heat that creates a special fire experience. It is also suitable for smaller rooms and can be optionally equipped with a catalyst and an electronic heating support device to keep combustion conditions and operation simple and efficient.



[ 6 KW ] 

# CORNA

Sleek, cubist cast iron stove with innovative technology



For more information about KLIMA PLUS, simply scan the QR code.

CORNA ES painted black



#### CORNA Facts:

- black lacquered, white enamelled
- 2 models: front view, corner view / 2 heights
- Dimensions (H/W/D): 125 or 139/38/38 cm
- KLIMA PLUS – including airflow volume regulator and recessed fire chamber bottom
- Accessories: Turning base, electronic heating support device, catalyst, cast iron storage attachment "plus" (black)

The slim, square wood-burning stove consists of individual cast iron elements and offers efficient heating performance with a modern design.



# Model overview

CORNA cast iron wood-burning stoves are available with a heat output of 4 to 6 kW. Pleasantly cosy heat ensures the special fire experience of the - optimally designed for well-insulated homes.



## CORNA ES L

Corner view, door hinge on the left

- H/W/D: 125 / 38 / 38 cm
- Colours: black lacquered, white enamelled
- Cast iron storage unit and turning base optional



## CORNA ES R

Corner view, door hinge on the right

- H/W/D: 125 / 38 / 38 cm
- Colours: black lacquered, white enamelled
- Cast iron storage unit and turning base optional



## CORNA high

Front view, high

- H/W/D: 139 / 38 / 38 cm
- Colour: black lacquered
- Cast iron storage unit and turning base optional



## CORNA

front view

- H/W/D: 125/38/38 cm
- Colours: black lacquered, white enamelled
- Cast iron storage unit (+ 14 cm height) and turning base optional



### CORNA high ES L/R

Corner view Door hinge on the left or right, high

- H/W/D: 139 / 38 / 38 cm
- Colour: black lacquered
- Cast iron storage unit and turning base optional



### CORNA PS

panoramic view

- H/W/D: 152 / 38 / 38 cm
- Colour: black lacquered

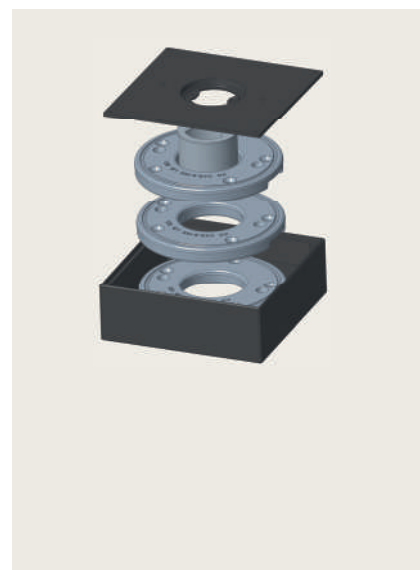

### Cast iron storage attachment

70 kg additional storage mass for approx. 3 hours more heat

- H/W/D: 15 / 38 / 38 cm
- Colour: black lacquered

[ 6 KW ] 

# CORNA PS

Fantastic panoramic view from  
three sides



CORNA PS



#### CORNA PS Facts:

- painted black
- removable door handle
- Dimensions (H/W/D): 152/38/38 cm
- KLIMA PLUS – including airflow volume regulator and recessed fire chamber bottom
- Accessories: Electronic heating support device, catalyst, LUC

The panoramic view of the open fire remains uninterrupted thanks to the frameless glazing. The front pane is fixed, while the side doors can be opened wide to add more wood.



PEPPA in white enamel

# PEPPA – Stylish enamel colours for elegant design

**PEPPA cast iron wood-burning stove offers excellent heat conduction and storage properties**

With its exquisite design and elegant enamel finish in a range of colours, it adds a special touch to any room. The stove is 1.30 metres high, has a diameter of 40 cm and is equipped with a curved, double-glazed glass door. On request, the stove can be rotated so that the fire remains visible from every angle.



[4-6 KW] 

# PEPPA

Efficient heating solution for homes with low heat requirements



Colour options: black-blue and petrol blue enamelled



The PEPPA in dark green enamel



#### PEPPA Facts:

- white, dark green, black-blue or petrol blue enamelled or black lacquered
- Dimensions (H/W/D): 135/40/40 cm
- KLIMA PLUS – including airflow volume regulator and recessed fire chamber bottom
- Accessories: Electronic heating support device, catalyst, LUC

The stoves with 4-6 kW heating output support environmentally friendly combustion. The optional heating support device indicates via LED when the combustion conditions are optimal or need to be adjusted.



[ 6 KW ] 

# NOVIA

Visible at first glance –  
a high-quality cast iron stove



NOVIA CL



#### NOVIA Facts:

- painted black
- 2 models: NOVIA C and NOVIA CL
- Dimensions (H/W/D):  
107/45/45 cm – NOVIA C  
120/45/45 cm – NOVIA CL
- with grate and ash pan
- Accessories: Electronic heating support device, LUC, LEDATRONIC (NOVIA CL)

The NOVIA combines high-quality materials and modern design to create an efficient, elegant heat source. The curved viewing panel offers a clear view of the flames, while the compact diameter of 45 cm allows it to be integrated into any home



[ 6 KW ] 

# VISPA

An eye-catcher – slim, curvy and elegantly shaped



**VISPA Facts:**

- 
- painted black
- 
- Dimensions (H/W/D): 111/53/53 cm
- 
- with grate and ash pan
- 
- Accessories: LUC
- 
- Accessories: Electronic heating support device, catalyst, LUC
- 

Made of cast iron, it impresses with its inwardly curved shape and outwardly curved glass panel, which offers a clear view of the flames. With a diameter of only 52 cm, it fits perfectly into any home – even smaller rooms.

APELLA  
[ 7 KW ] 

# APELLA

The finest contours and  
cast iron quality



Design: kramerDesign

APELLA

APELLA small  
[ 6 KW ] 



**APELLA Facts:**

- painted black
- 2 models: APELLA and APELLA small
- Dimensions (H/W/D): 77/79/54 cm – APELLA  
73/61/45 cm – APELLA small
- Exclusive fire enjoyment: curved glass pane
- including airflow volume regulator
- Accessories: LUC

The curved glass pane in the swivelling firebox door always offers a generous view of the flames.

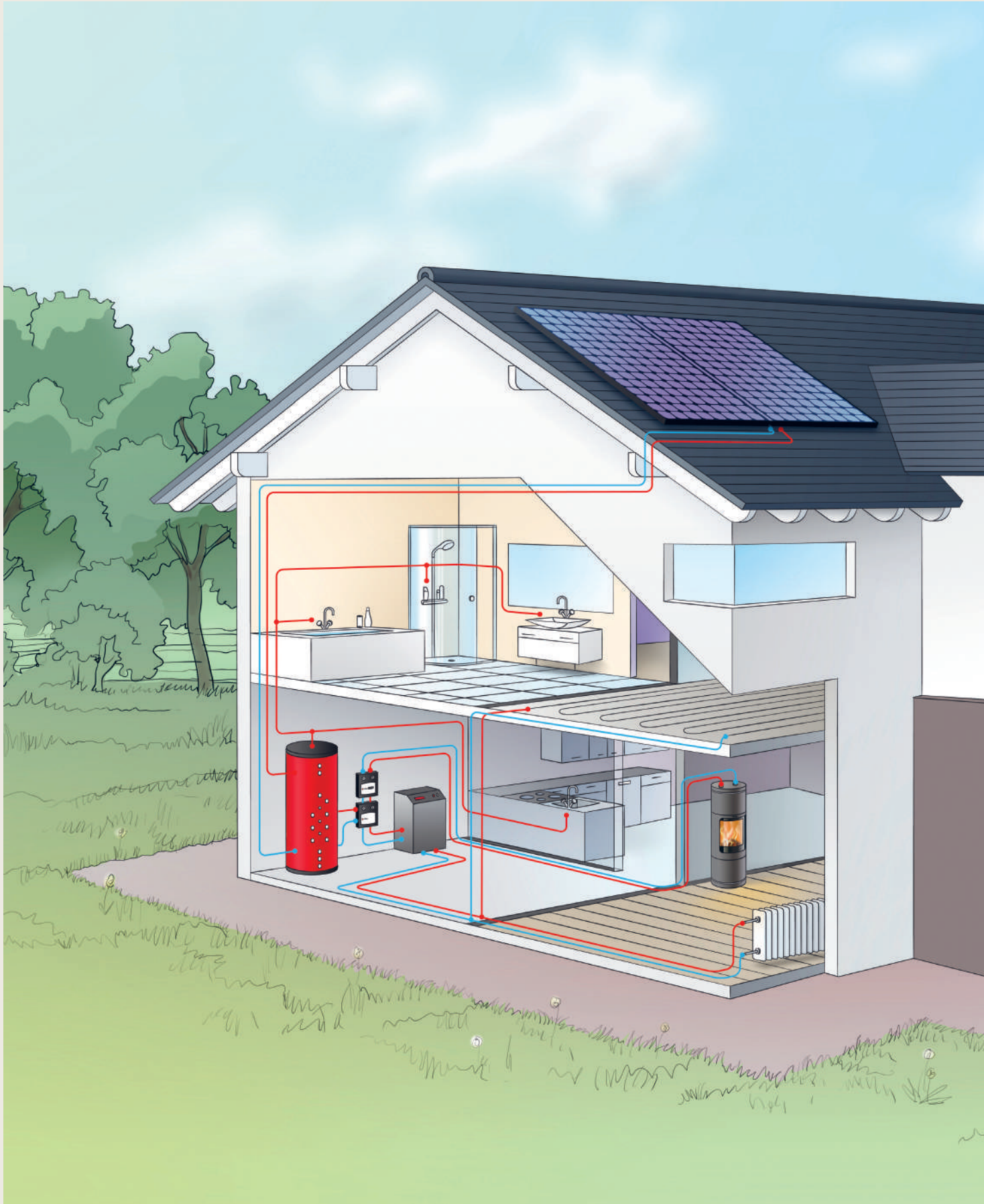



## How does water technology work?

A lot of energy is released when wood is burned. This energy is released directly into the room where the stove is located. In a stove with water technology, however, a large part of the energy released is efficiently made available to the heating system via the heat exchanger.

With optimally coordinated components such as pump unit and ZAE, you can create a perfectly matched overall system.

A wood-burning stove with water technology makes an effective contribution to the overall heating requirement directly via its water output to the heating system, but also via its direct output to the room. This means that the heat pump or, for example, the conventional oil or gas heating system can remain switched off as long as the heat output of the wood-burning stove and any additional solar thermal system cover the current heating requirement.

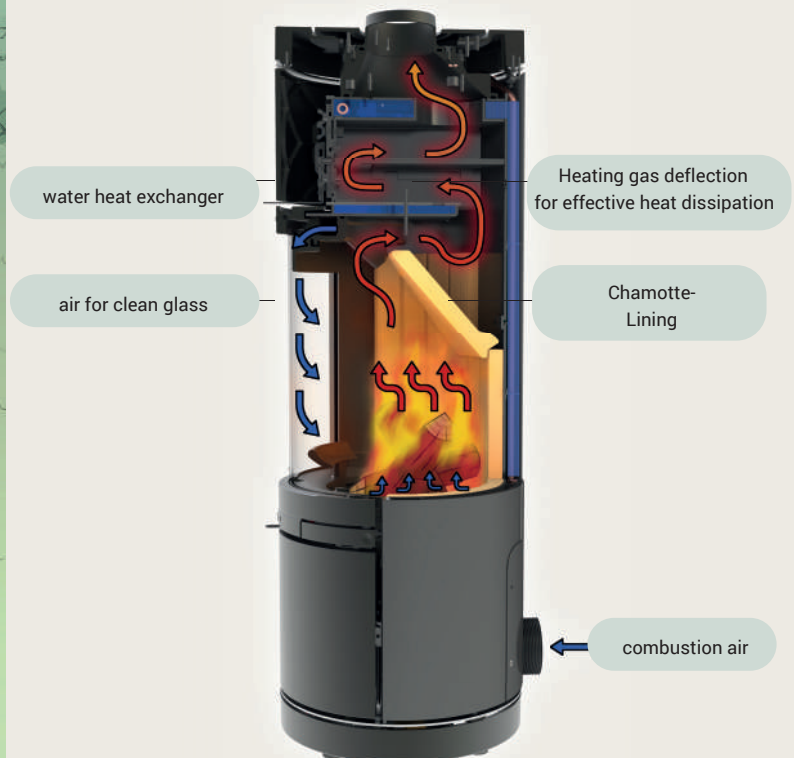

[ 8 KW ] 

# GREENA W

Minimalist design with functional perfection and water technology



For more information about KLIMA PLUS, simply scan the QR code.



GREENA W pure



#### GREENA Facts:

- painted black
- 2 models: GREENA pure with a smooth surface and GREENA nature with a natural texture
- Dimensions (H/W/D): 134/46/48 cm
- Power distribution: 55% direct power  
45% water power
- Includes airflow volume regulator and recessed fire chamber bottom
- Accessories: Complete station KS04, ZAE, electric technical heating support device, catalyst, LEDATRONIC, LUC

GREENA W – ideal for low-energy houses and as a supplement to heat pump and solar thermal systems.



[ 8 KW ] 

# NOVIA W

Compact water technology for maximum living comfort



NOVIA W

**NOVIA W Facts:**

- painted black
- Dimensions (H/W/D): 132/45/45 cm
- Power distribution: 52% direct power  
48% water power
- Accessories: KS04 complete station, ZAE,  
electronic heating support device, LEDATRONIC,  
LUC

The stove fire warms the living room and at the same time supports the heating system of the house.



[ 8 KW ] 

# DELTA W

Compact water technology for maximum living comfort



Design: kramerDesign

DELTA W

**DELTA W Facts:**

- 
- painted black
- 
- Dimensions (H/W/D): 133/50/52 cm
- 
- Power distribution: 52% direct power  
48% water power
- 
- Accessories: KS04 complete station, ZAE,  
electronic heating support device, LEDATRONIC,  
LUC
- 

DELTA's floor plan is triangular in shape, with all three sides and the large viewing pane curved. The stove fire not only heats the living room, but also supports the house's heating system.



[13 KW] 

# FONDIA

Unusual appearance:  
wave design at surface



**FONDIA Facts:**

- painted black
- Dimensions (H/W/D): 123/69/53 cm
- Power distribution: 40% direct power  
60% water power
- Accessories: Complete station KS04, ZAE, LUC

Flowing contours give the FONDIA its distinctive look. Modern water technology and innovative design make this heat source an all-round genius.



# LEDATRONIC

Comfort and efficiency - ingeniously controlled

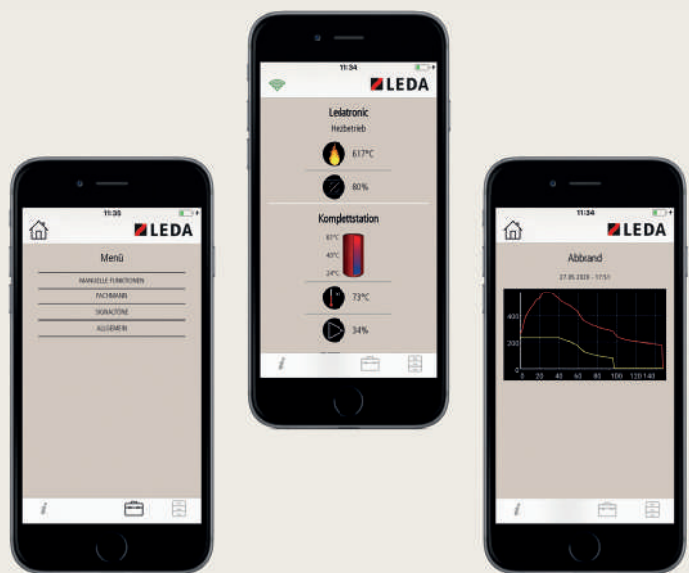

LEDATRONIC app  
for all settings and views

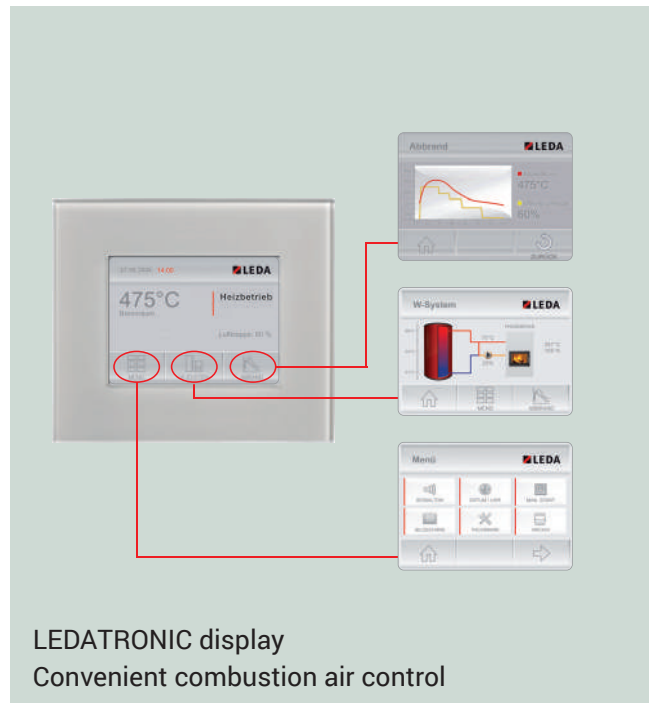

Modern heating appliances rely on particularly low-pollutant combustion and low fuel consumption. The precise adjustment of the combustion air is crucial for this – in every phase of combustion. This is exactly where LEDATRONIC comes in: it regulates the combustion process automatically, efficiently and with low emissions – better than would be possible manually.

- Optimised combustion: best possible and continuous adjustment of the combustion air supply throughout the entire combustion process.
- Energy saving: High efficiency and automatic closure of the air supply at the end of combustion reduce fuel consumption.
- Comfortable and safe: No operating errors possible, safe operation – even in the event of a power failure.
- Smart controllable: Free LEDATRONIC app for Android/iOS, can be integrated into a smart home building system via TCP module
- Optional with display: touchscreen graphic display
- Simple, clear user interface with self-explanatory menu navigation via icons

# LUC

Electronic draft monitoring device -  
regulated with safety

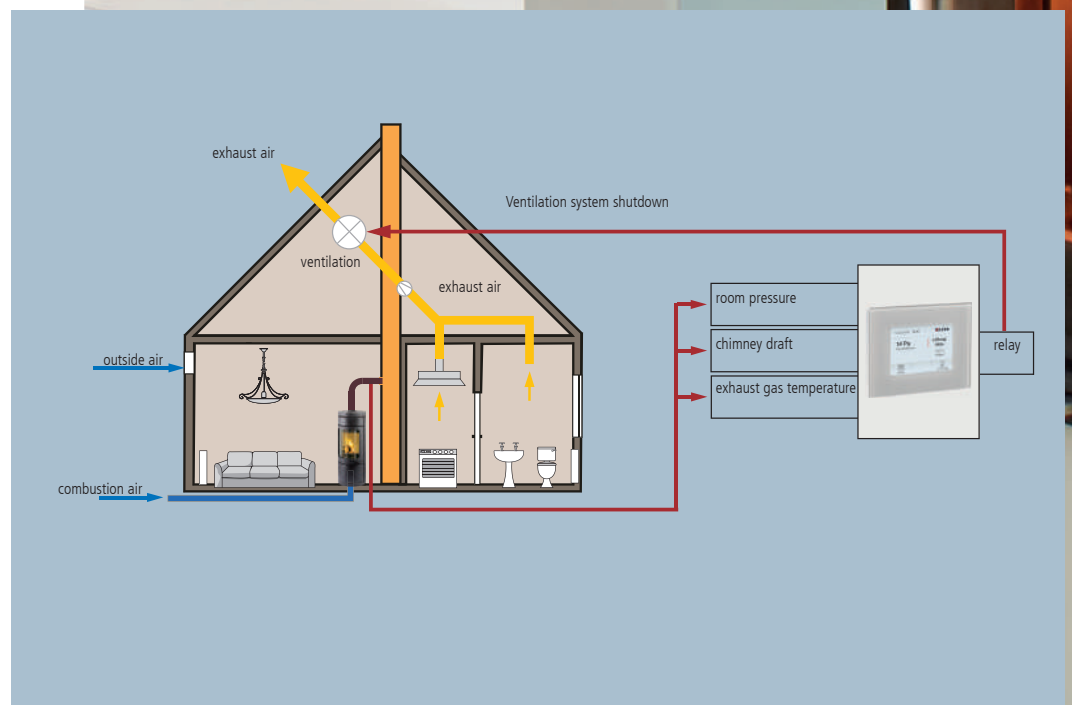
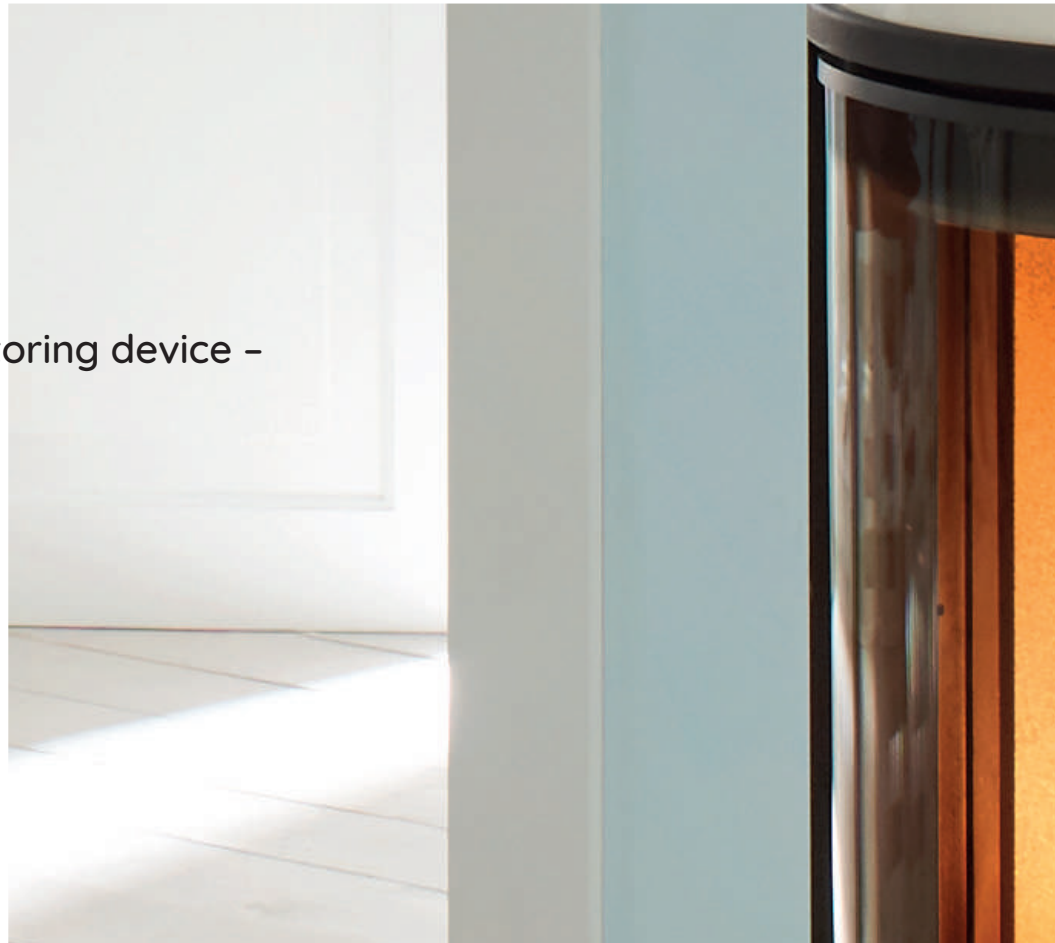

General building authority  
approval from the DIBt  
(German Institute for  
Building Technology)



LUC Draft monitoring device Display

Ventilation systems and extractor hoods can create negative pressure – as can chimneys, so that they can extract smoke gases from a fireplace. This can lead to dangerous malfunctions: a powerful or defective ventilation system could draw smoke gases back into the living space. LUC provides reliable protection against this risk – for maximum safety when both systems are working together.

The intelligent control system continuously monitors the safe functioning of the exhaust gas extraction system during operation of a fireplace. In the event of a malfunction, LUC automatically switches off the ventilation system.

### LUC Facts

- Modern graphic display with touchscreen surface and discreet glass frame, dimensions: 112 x 94 mm
- Simple, clear user interface with self-explanatory menu navigation via icons
- All functions can be viewed in combination with LEDATRONIC via the free app (iOS/Android).

# CATALYST & HEATING SUPPORT DEVICE

Innovative components for low-emission combustion and economical wood consumption

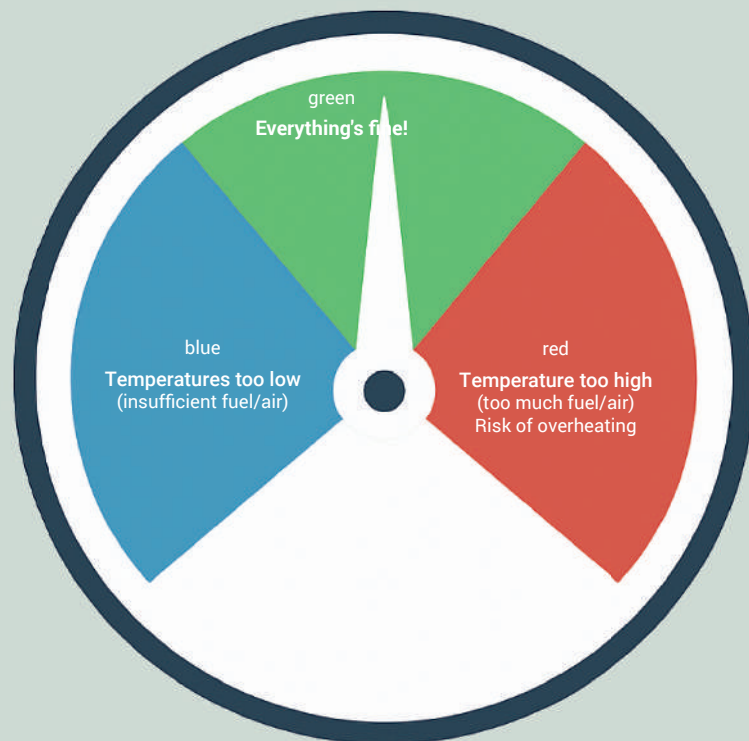

The heating support device shows you whether you are operating your stove within the optimum range.



## What does the catalyst do?

The catalyst is an open-pored ceramic module with an innovative coating. These modules are integrated in the area above the combustion chamber and are flowed through by the still hot combustion gases. This primarily reduces CO emissions, but also reduces hydrocarbons.

This means that a wood-burning stove with a catalyst not only heats with low emissions at its rated heat output, but also when the stove is operating at a slightly lower output. This guarantees user-friendly, low-emission heating that meets your needs across a wider range, making it suitable for everyday use.

## What does the heating support device do?

Optimal heating operation is determined not only by a correctly dimensioned chimney, but also by the amount of wood fed into the stove and the setting of the air valve lever. The operator must therefore "learn" to heat the stove in the correct power range.

The heating support device supports him in this. A discreet LED light indicates whether the stove is operating in the correct heating range – comparable to a switch point indicator in a car – and acts as an indicator for "correct heating with wood".



## AIRFLOW VOLUME REGULATOR

Innovative air valve in the bottom of combustion chamber

- Extension of the fireplace's operating range for higher chimney draughts without secondary air supply
- Improvement of overall combustion through adjusted volume flow for combustion air
- Simple on-site adjustment according to chimney calculation
- Heating booster

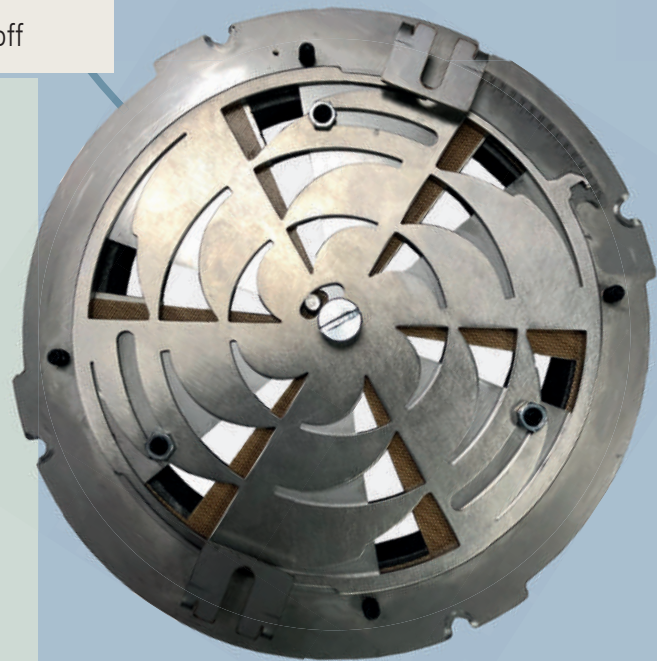

## chimney calculation

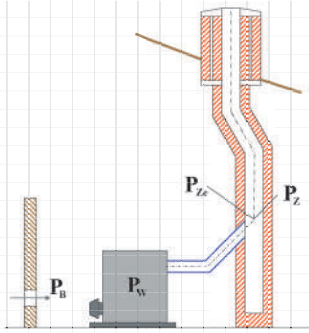

## What does a flow controller do?

If the delivery pressure of the stove or fireplace system does not match the output of the appliance, the combustion process is impaired and may result in higher emissions, dirty windows or inefficient combustion.

With the volume flow regulator (VFR), the appliance can be adjusted to the delivery pressure conditions in the home for the first time, ensuring low-emission combustion and the best possible efficiency.

Alternative measures, such as throttle valves, secondary air devices, exhaust fans or chimney extensions, only improve nominal heat output and do not compensate for fluctuations in actual operation.

## Airflow volume regulators and LEDATRONIC

The combination of a stove or fireplace with VSR and an LEDATRONIC combustion air control system optimises the function of the fireplace with its chimney and largely eliminates operating errors – reliable, efficient and low-emission.

Train adjustment via simple setting

wood-burning stoves

# Technical specifications

## KLIMAPLUS

Why should you choose this option? For more information, simply scan the QR code.



## Nominal Heat Output

indicates the maximum amount of heat that the fireplace or stove can generate under normal conditions.

## Efficiency

indicates how much of the energy contained in the fuel is actually converted into usable heat. It is usually expressed as a percentage. Particularly efficient stoves therefore have a high efficiency rating, but still release some energy for the chimney to function. Stoves with an efficiency of at least 80% or slightly above offer this optimal and balanced function: they are very efficient, but still ensure that the chimney functions properly.

## Safety Distances

For stoves, the specified minimum distances to combustible materials, windows and access areas must be observed.

## Log length / Size of Combustion Chamber

We also provide information on the wood length for which the model is designed. The optimum wood length shows how the stove was tested; the maximum length is based on the size of the firebox. The wood length is crucial for efficient combustion and maximum heat output.

## Dimensions

You will find the dimensions (height, width, depth) for the ideal location for your wood-burning stove on our product pages.

More detailed technical data and dimensional drawings can be found at [www.leda.de](http://www.leda.de).

## COLONA



## EDDA











models		EDDA small	EDDA plus	EDDA tea
Building law review in accordance with	EN 15250	EN 16510-2-1		
Environmental requirements met	Ecodesign - Regulation (EU) 2015-1185	Ecodesign - Regulation (EU) 2015-1185		
energy efficiency class				
KLIMAPLUS				
recessed fire chamber bottom				
airflow volume regulator				
catalyst				
heating support device				
LEDATRONIC				
LUC				
Nominal heat output [kW]	1,7 <sup>1)</sup>	6	6	6
efficiency	≥ 81	≥ 78	≥ 81	≥ 81
Smoke pipe outlet [mm]	150	130	130	130
Smoke pipe connection at top/rear	■ / ■	■ / -	■ / ■	■ / ■
External air connection [mm]	100	80	80	80
double glazing	■	■	■	■
Weight, approx. [kg]	480	174	278	277
Safety distances <sup>2)</sup> (side/rear/front) [cm]	30/ 15/ 80	60 / 35 / 100	60 / 35 / 100	60 / 35 / 100
Suitable for multiple use of the chimney	■	■	■	■
Wood/wood briquettes	■	■	■	■
Optimal/maximum log length [cm]	25 / 25	25 / 33	25 / 33	25 / 33
Comb. chamber size approx. [HxWxD cm]	39 x 22 x 30	40 x 25 x 34	40 x 25 x 34	40 x 25 x 34
Door hinge left/right	■ / -	- / ■	- / ■	- / ■

■ □ optional

<sup>1)</sup> Room heating capacity based on discharge period (= heat output over approx. 9 hours)

<sup>2)</sup> Where applicable, additional safety distances specified in the technical documentation must be taken into account and observed.

	GREENA	DELTA	NOVIA	ANTIGUA
models	 GREENA pure GREENA nature	 DELTA plus	 NOVIA plus	 ANTIGUA H
Building law review in accordance with	EN 16510-2-1	EN 16510-2-1	EN 16510-2-1	EN 16510-2-1
Environmental requirements met	Ecodesign - Regulation (EU) 2015-1185	Ecodesign - Regulation (EU) 2015-1185	Ecodesign - Regulation (EU) 2015-1185	Ecodesign - Regulation (EU) 2015-1185
energy efficiency class				
KLIMAPLUS	<input checked="" type="checkbox"/>			
recessed fire chamber bottom	<input checked="" type="checkbox"/>			
 airflow volume regulator	<input checked="" type="checkbox"/>			
catalyst	<input type="checkbox"/>			
heating support device	<input type="checkbox"/>	<input type="checkbox"/>		
LEDATRONIC	<input type="checkbox"/>	<input type="checkbox"/>	<input type="checkbox"/>	
LUC	<input type="checkbox"/>	<input type="checkbox"/>	<input type="checkbox"/>	<input type="checkbox"/>
Nominal heat output [kW]	6	6	6	8
efficiency	≥ 81	≥ 80	≥ 81	≥ 81
Smoke pipe outlet [mm]	130	130	130	130
Smoke pipe connection at top/rear	■ / -	■ / -	■ / -	■ / ■
External air connection [mm]/	100	100	100	100
double glazing	-	-	-	-
Weight, approx. [kg]	197	299	269	164 <sup>2)</sup>
Safety distances <sup>1)</sup> (side/rear/front) [cm]	40 / 20 / 90	20 / 5 / 70	45 / 17,5 / 80	70 / 40 / 120
Suitable for multiple use of the chimney	■	■	■	■
Wood/wood briquettes	■	■	■	■
Optimal/maximum log length [cm]	20 / 25	22 / 25	20 / 25	30 / 33
Comb. chamber size approx. [HxWxD cm]	61 x 27 x 25	53 x 30 x 30	53 x 30 x 30	32 x 43 x 20
Door hinge left/right	■ / -	■ / -	■ / -	- / ■

COLONA lite

CORNA

PEPPA



COLONA lite, 2 rings  
COLONA lite, 3 rings  
COLONA lite 6 rings

CORNA  
CORNA high

CORNA ES  
CORNA ES high

CORNA PS

EN 16510-2-1

EN 16510-2-1

EN 16510-2-1

Ecodesign - Regulation  
(EU) 2015-1185

Ecodesign - Regulation (EU) 2015-1185















Ecodesign - Regulation  
(EU) 2015-1185

COLONA lite	CORNA	CORNA ES	CORNA PS	PEPPA
6	4 / 6	6	6	6
≥ 81	≥ 81	≥ 81	≥ 81	≥ 81
130	130	130	130	130
■ / -	■ / ■	■ / ■	■ / -	■ / -
100	100	100	100	100
■	■	-	■	-
246 / 279 / 321	267 / 292	248 / 275	285	250
50 / 50 / 110	40 / 35 / 80	40 <sup>3)</sup> / 40 / 80	60 / 38 / 60	48 / 43 / 80
■	■	■	■	■
■	■	■	■	■
20 / 25	17 / 20	20 / 20	20 / 20	17 / 20
39 x 22 x 30	61 x 27 x 25	61 x 27 x 25	61 x 27 x 25	61 x 26 x 26
■ / -	■ / -	■ / ■	■ / ■	■ / -

<sup>1)</sup> Where applicable, additional safety distances specified in the technical documentation must be observed and complied with.

<sup>2)</sup> approx. 500 kg with attachment

<sup>3)</sup> 40 cm safety distance on the side without a pane, 80 cm on the side with a pane

	NOVIA	VISPA	APELLA
models	 NOVIA C NOVIA CL		 APELLA APELLA small
Building law review in accordance with	British Standard 16510-2-1	British Standard 16510-2-1	British Standard 16510-2-1
Environmental requirements met	Ecodesign - Regulation (EU) 2015-1185	Ecodesign - Regulation (EU) 2015-1185	Ecodesign - Regulation (EU) 2015-1185
energy efficiency class			
KLIMAPLUS			
recessed fire chamber bottom			
 airflow volume regulator			
catalyst			
heating support device			
LEDATRONIC			
LUC			
Nominal heat output [kW]	6	6	7 / 6
efficiency	≥ 81	≥ 81	≥ 78 / ≥ 81
Smoke pipe outlet [mm]	130	130	130
Smoke pipe connection at top/rear	■ / -	■ / -	■ / ■
External air connection [mm]/	100	100	100
double glazing	-	-	-
Weight, approx. [kg]	200 / 210	260	? / 212
Safety distances (side/rear/front) [cm]	45 / 17,5 / 80	45 / 17,5 / 80	60 / 40 / 100
Suitable for multiple use of the chimney	■	■	■
Wood/wood briquettes	■	■	■
Optimal/maximum log length [cm]	20 / 25	20 / 25	25 / 50
Comb. chamber size approx. [HxWxD cm]	53 x 30 x 30	53 x 30 x 30	31 x 55 x 25
Door hinge left/right	■ / -	■ / -	- / ■

# Scan us.



LEDA website



Facebook



Instagram











Pinterest



YouTube

<sup>1)</sup> Stone wall is not a combustibile wall, tested with 1 m flue pipe

	GREENA	NOVIA	DELTA	FONDIA
				
	GREENA W	NOVIA W	DELTA W	FONDIA
Building law review in accordance with	EN 16510-2-1	EN 16510-2-1	EN 16510-2-1	EN 13240
Environmental requirements met	Ecodesign - Regulation (EU) 2015-1185	Ecodesign - Regulation (EU) 2015-1185	Ecodesign - Regulation (EU) 2015-1185	Ecodesign - Regulation (EU) 2015-1185
energy efficiency class				
 KLIMAPLUS	■			
recessed fire chamber bottom	■			■
airflow volume regulator	■			
catalyst				
heating support device	□	□	□	
LEDATRONIC <sup>2</sup>	□	□	□	□
LUC <sup>3</sup>	□	□	□	□
Nominal heat output [kW]	8	8	8	13
water side / direct [kW]	3,6 / 4,4	4,2 / 4,5	4,2 / 4,5	7 / 6
efficiency	≥ 81	≥ 81	≥ 81	≥ 81
Smoke pipe outlet [mm]	130	130	130	180
Smoke pipe connection at top/rear	■ / -	■ / -	■ / -	■ / ■
External air connection [mm]/	100	100	100	125
double glazing	-	-	-	-
Weight, approx. [kg]	265	265	269	405
Safety distances (side/rear/front) [cm]	30 / 20 / 80	30 / 20 / 80	30 / 20 / 80	20 / 20 / 80
Suitable for multiple use of the chimney	■	■	■	■
Wood/wood briquettes	■	■	■	■
Optimal/maximum log length [cm]	20 / 25	20 / 25	20 / 25	33 / 33
Comb. chamber size approx. [HxWxD cm]	40 x 29 x 29	41 x 00 x 30	40 x 30 x 30	40 x 30 x 20
Door hinge left/right	■ / -	■ / -	■ / -	■ / -

## Legal notice

**Publisher:**

LEDA Werk Limited Partnership  
Heating technology – industrial casting  
PO Box 1160, D - 26761 Leer  
[www.leda.de](http://www.leda.de)

Printed: January 2026

**Edition EN V1 0126**

This renders all previous versions of the brochure invalid.  
Subject to (technical) changes. Colour variations due to  
printing techniques.

LEDA accepts no liability for any errors (including  
typographical errors) or incomplete information in this  
document. No rights can therefore be derived from the  
content of this publication.

**Legal notice:**

Apple, iPhone, iPad, iOS, App Store (Apple Inc.) and  
Google, Android, Google Play, Play Store (Google LLC)  
are registered trademarks or registered brands. They  
are registered in the United States and are therefore  
protected by copyright and trademark law.

Your LEDA dealer/craftsman partner company

**LEDA Werk GmbH & Co. KG**  
PO Box 1160  
D - 26761 Leer

Tel. +49 491 6099 - 0  
Fax +49 491 6099 - 290

[www.leda.de](http://www.leda.de)  
[info@www.leda.de](mailto:info@www.leda.de)

LEDA GPKÓ EN V1 0126

